

# Encoder



## Specifications:

Contact rating:	5 V DC, 10 mA
Insulation resistance:	> 100 MΩ
Dielectric strength:	300 V, 50 Hz for the duration of 1 minute
Operating temperature:	-10 °C to +85°C
Rotational/Detent torque:	0,5/1,2 Ncm
Pulses/Detents per turn:	15/30 or 20/20
Mechanical life:	> 15 000 cycles
Pushbutton (optional):	actuation force 6 N, travel 0,5 mm, life > 25 000 operations
Contacts:	silver-plated
Terminals:	silver-plated
Mounting:	on pc-board
	single hole mounting, bushing M 7 x 0,75
Soldering conditions:	auto-soldering – max.: 5 sec, 260 °C

## Models:

MER11-15125B

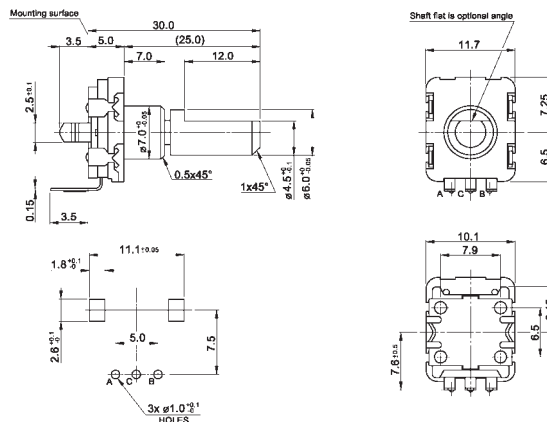

MERP11-15325B

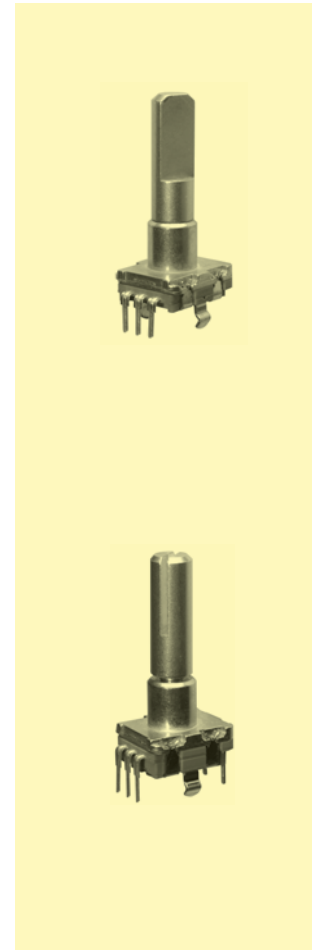
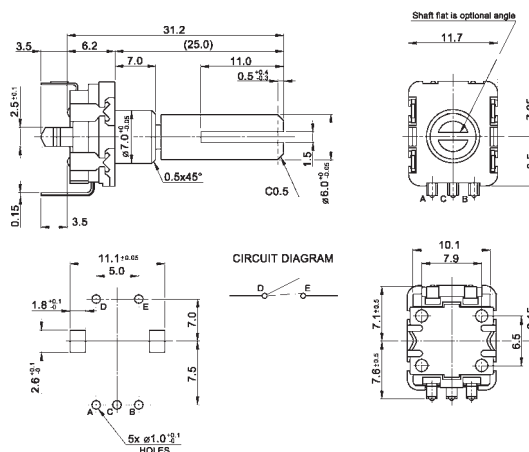



# Encoder

## Models:

MER11-15215A-R

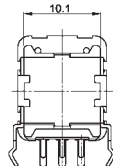
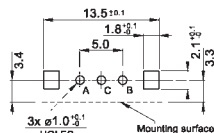
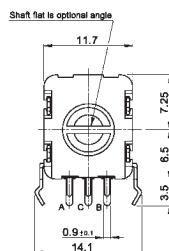
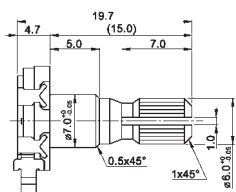

MERP11-2042BM7-R

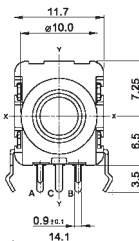
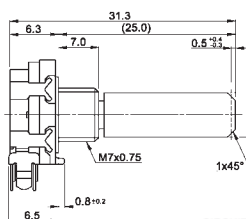

CIRCUIT DIAGRAM

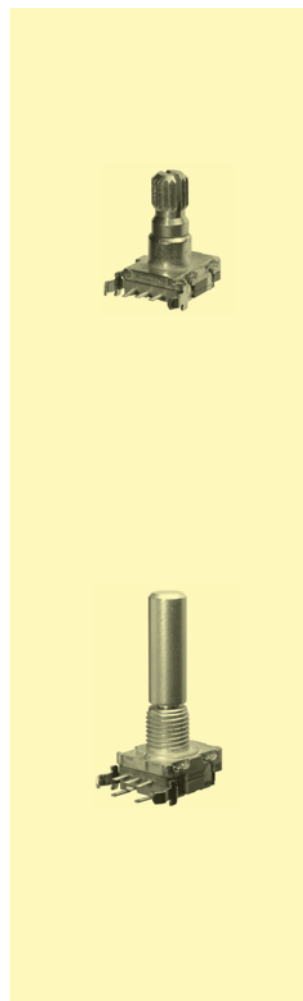
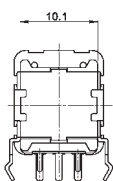
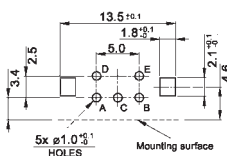

## Output signal format:

Shaft rotational direction	Signal	Output
C.W.	Terminal A-C	OFF ON
	Terminal B-C	OFF ON
C.C.W.	Terminal A-C	OFF ON
	Terminal B-C	OFF ON

## Ordering code 11 mm Encoder:

MER    11      -

### Switch function:

- no switch
- switch

### Shaft type:

- 1 flat shaft
- 2 knurled shaft
- 3 cut shaft
- 4 round shaft

### Bushing:

- A 5 mm
- B 7 mm

### Orientation:

- horizontal
- vertical

### PCB mounting:

- through hole
- SMD

### Number of pulses:

- 15 15 pulses
- 20 20 pulses

### Shaft length:

- 15 15 mm
- 20 20 mm
- 25 25 mm

### Bushing thread:

- M7 M7
- no thread

# Encoder für SMD

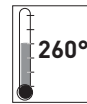

## Specifications:

Contact rating:	5 V DC, 10 mA
Insulation resistance:	> 100 MΩ
Dielectric strength:	300 V, 50 Hz for the duration of 1 minute
Operating temperature:	-40 °C to +85 °C
Rotational/Detent torque:	0,5/1,0 Ncm
Pulses/Detents per turn:	15/30 or 20/20
Mechanical life:	> 15 000 cycles
Pushbutton (optional):	actuation force 4 N, travel 0,5 mm, life > 25 000 operations
Contacts:	silver-plated
Terminals:	silver-plated
Mounting:	on pc-board – SMD

## Models:

MERPS11-15213

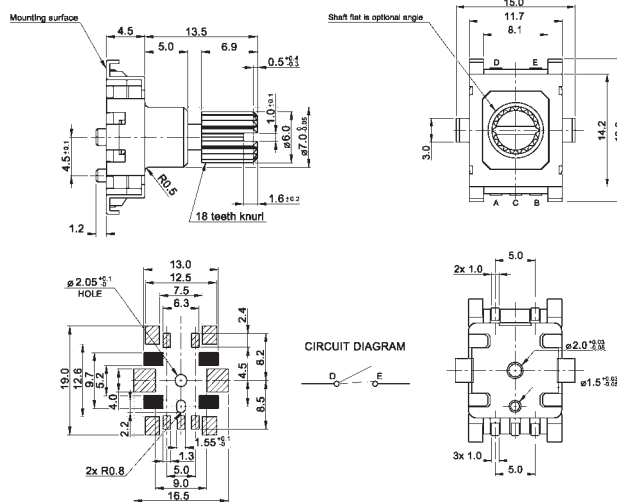

MERS11-15295

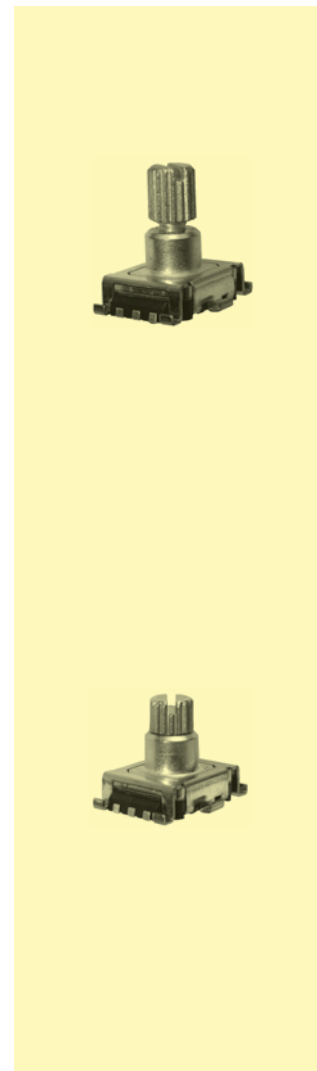
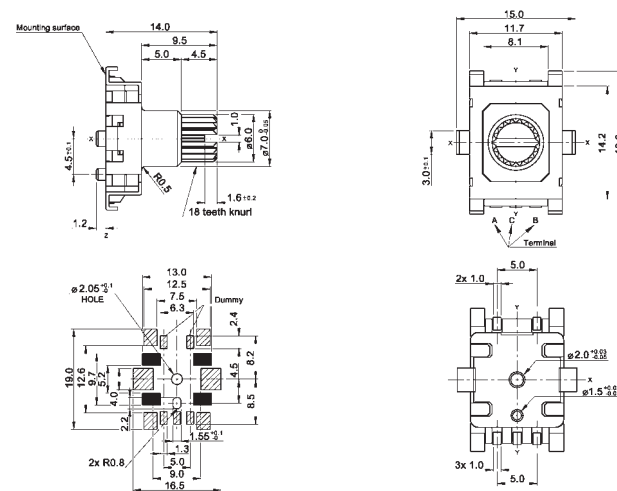

**knitter-switch**

Distributor: Sider Electronic Industries Ltd.  
 Tel: 852-23892522 Fax: 852-23574546  
 Email: info@sider.com.hk URL: www.sider.com.hk