

### Small-sized Side-operational SMD Light Touch Switches

Type: **EVQPU**

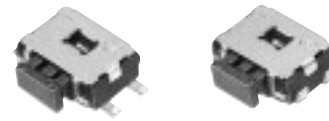

#### ■ Features

- External dimensions : 4.7 mm×3.5 mm, Height 1.65 mm
- A wide range of terminal type : J-bent, Straight

#### ■ Recommended Applications

- Car navigation, Car audio

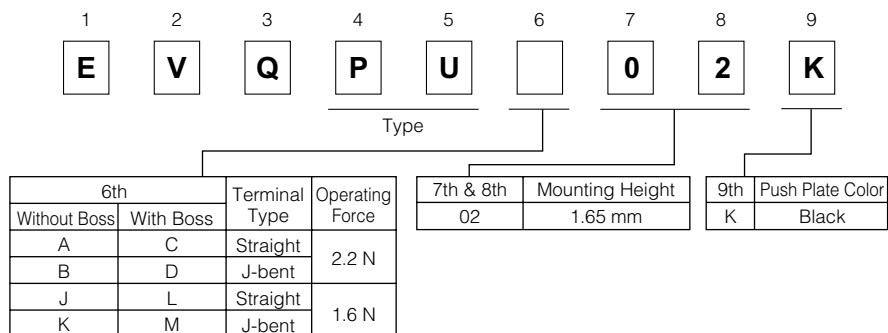

#### ■ Explanation of Part Numbers



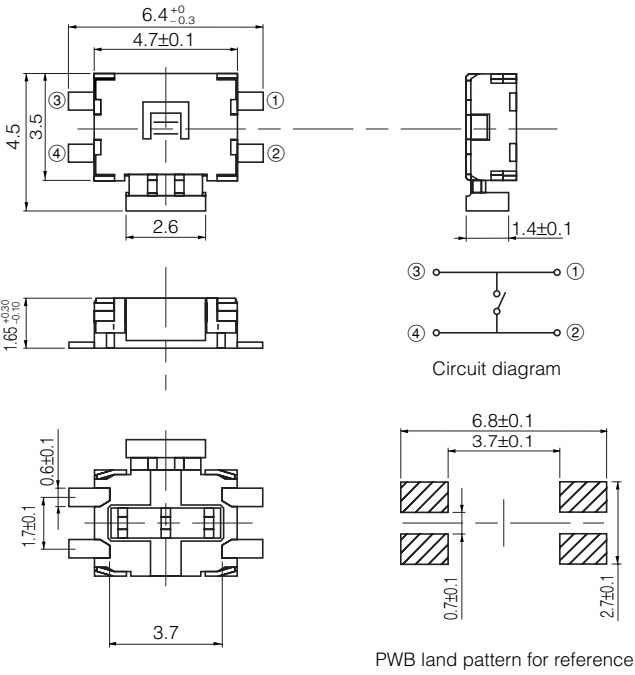

#### ■ Specifications

Type	Snap action / Push-on type SPST	
Electrical	Rating	10 $\mu$ A 2 Vdc to 50 mA 12 Vdc (Resistive load)
	Contact Resistance	500 m $\Omega$ max.
	Insulation Resistance	100 M $\Omega$ min. (at 100 Vdc)
	Dielectric Withstanding Voltage	250 Vac for 1 minute
	Bouncing	10 ms max. (ON, OFF)
Mechanical	Operating Force	1.6 N <sup>+0.7</sup> <sub>-0.4</sub> N      2.2 N <sup>+0.8</sup> <sub>-0.7</sub> N
	Travel	0.3 mm <sup>+0.1</sup> <sub>-0.2</sub> mm
	Push Strength	30 N (1 minute)
Endurance	Operating Life	100000 cycles min.
Operating Temperature		-20 °C to +70 °C
Storage Temperature		-40 °C to +85 °C (Bulk) -20 °C to +60 °C (Taping)
Minimum Quantity/Packing Unit		4000 pcs. Embossed Taping (Reel Pack)
Quantity/Carton		20000 pcs.

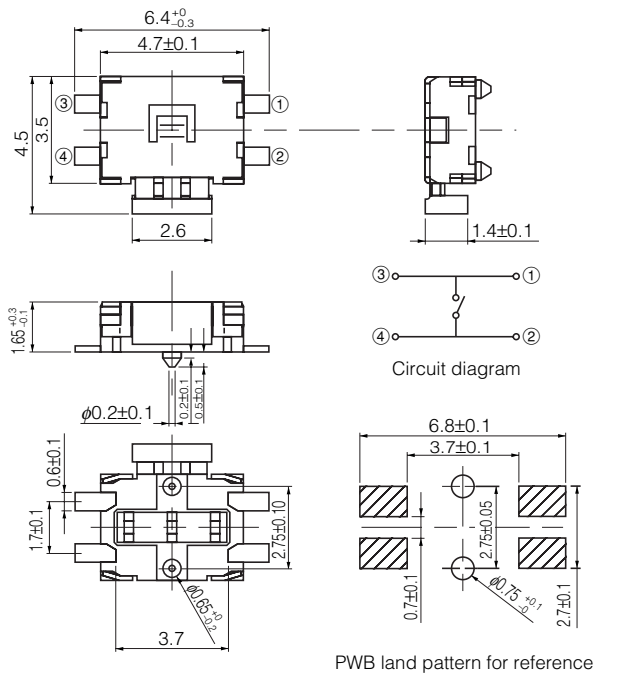
■ Dimensions in mm (not to scale)

<p>No. 1</p> <p><b>EVQPUJ</b> <b>EVQPUA</b></p> <p>(Embossed Taping)</p> <p>With straight terminals Without boss</p> 				
<p>Part Numbers</p>	<p>Operating Force</p>	<p>Height</p>	<p>Push Plate Color</p>	<p>Operating Life</p>
<p>EVQPUJ02K</p>	<p>1.6 N</p>	<p>1.65 mm</p>	<p>Black</p>	<p>100000 cycles</p>
<p>EVQPUA02K</p>	<p>2.2 N</p>	<p>1.65 mm</p>	<p>Black</p>	<p>100000 cycles</p>
<p>No. 2</p> <p><b>EVQPUL</b> <b>EVQPUC</b></p> <p>(Embossed Taping)</p> <p>With straight terminals With boss</p> 				
<p>Part Numbers</p>	<p>Operating Force</p>	<p>Height</p>	<p>Push Plate Color</p>	<p>Operating Life</p>
<p>EVQPUL02K</p>	<p>1.6 N</p>	<p>1.65 mm</p>	<p>Black</p>	<p>100000 cycles</p>
<p>EVQPUC02K</p>	<p>2.2 N</p>	<p>1.65 mm</p>	<p>Black</p>	<p>100000 cycles</p>

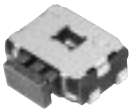
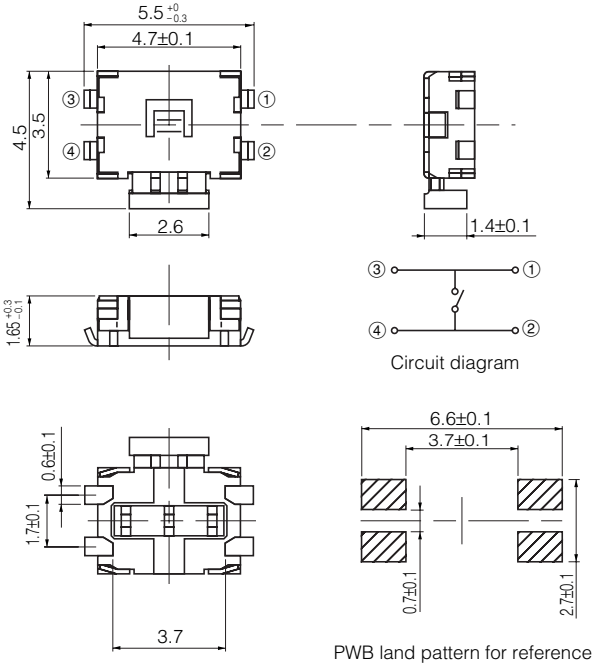
■ Dimensions in mm (not to scale)

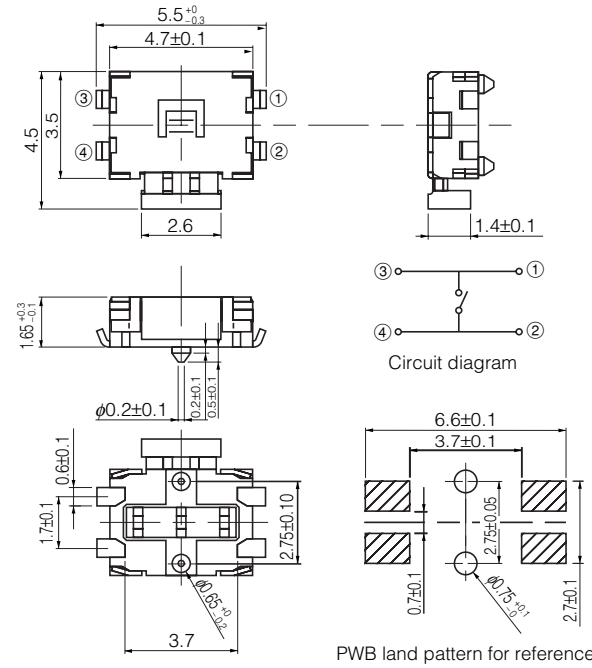
<p>No. 3</p> <p><b>EVQPUK EVQPUB</b></p> <p>(Embossed Taping)</p> <p>With J-bent terminals Without boss</p> 				
<p>Part Numbers</p>	<p>Operating Force</p>	<p>Height</p>	<p>Push Plate Color</p>	<p>Operating Life</p>
<p>EVQPUK02K</p>	<p>1.6 N</p>	<p>1.65 mm</p>	<p>Black</p>	<p>100000 cycles</p>
<p>EVQPUB02K</p>	<p>2.2 N</p>	<p>1.65 mm</p>	<p>Black</p>	<p>100000 cycles</p>
<p>No. 4</p> <p><b>EVQPUM EVQPUD</b></p> <p>(Embossed Taping)</p> <p>With J-bent terminals With boss</p> 				
<p>Part Numbers</p>	<p>Operating Force</p>	<p>Height</p>	<p>Push Plate Color</p>	<p>Operating Life</p>
<p>EVQPUM02K</p>	<p>1.6 N</p>	<p>1.65 mm</p>	<p>Black</p>	<p>100000 cycles</p>
<p>EVQPUD02K</p>	<p>2.2 N</p>	<p>1.65 mm</p>	<p>Black</p>	<p>100000 cycles</p>

### ■ Recommended Reflow Soldering Conditions

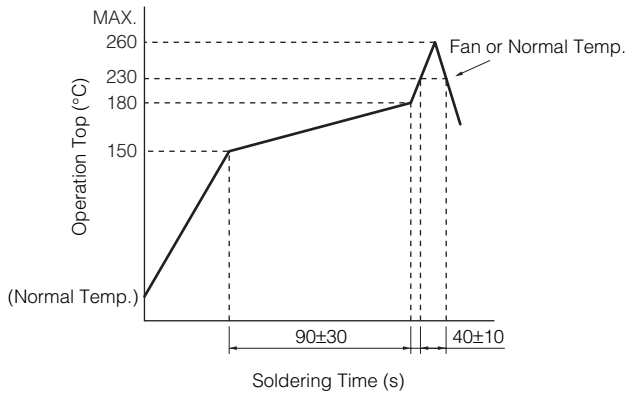

### ● Embossed Carrier Taping

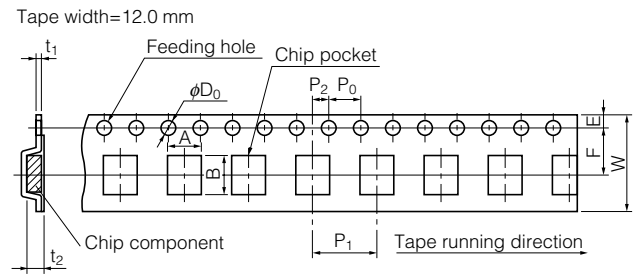

Unit: mm

Part No.	Height	A	B	W	F	E	$P_1$	$P_2$	$P_0$	$D_0$ Dia.	$t_1$	$t_2$
EVQPU	1.65	$7.0 \pm 0.2$	$5.75 \pm 0.20$	$12.0 \pm 0.3$	$5.78 \pm 0.20$	$1.75 \pm 0.10$	$8.0 \pm 0.1$	$2.0 \pm 0.1$	$4.0 \pm 0.1$	$1.5_{-0}^{+0.1}$	$0.35 \pm 0.05$	$2.4 \pm 0.2$

### ● Standard Reel Dimensions in mm (not to scale)

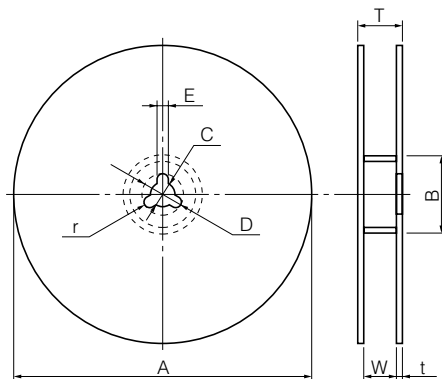

Item	A	B	C	D	E
Rate (mm)	$\phi 370.0 \pm 2.0$	$\phi 50.0$ min.	$\phi 13.0 \pm 0.5$	$\phi 21.0 \pm 1.0$	$2.0 \pm 0.5$

Item	W	T	t	r
Rate (mm)	$14.0 \pm 1.5$	—	1.0 to 3.0	$1.0 \pm 0.5$