

General Specifications

Electrical Capacity (Resistive Load)

Power Level (silver): 3A @ 125V AC or 3A @ 250V AC or 3A @ 30V DC
Logic Level (gold): 0.4VA maximum @ 28V AC/DC maximum
 (Applicable Range 0.1mA ~ 0.1A @ 20mV ~ 28V)

Other Ratings

Contact Resistance: 50 milliohms maximum for silver; 100 milliohms maximum for gold
Insulation Resistance: 200 megohms minimum @ 500V DC
Dielectric Strength: 1,000V AC minimum between contacts for 1 minute minimum;
 1,500V AC minimum between contacts & case for 1 minute minimum
Mechanical Life: 1,000,000 operations minimum for momentary circuit
 200,000 operations minimum for maintained circuit
Electrical Life: 100,000 operations minimum
Nominal Operating Force: Single pole: 1.5N
 Double pole: 3.0N
Contact Timing: Nonshorting (break-before-make)
Travel: Pretravel .059" (1.5mm); Overtravel .059" (1.5mm); Total Travel .118" (3.0mm)

Materials & Finishes

Bezel: Black: Glass fiber reinforced polyamide (UL94V-0); Chrome plated: Chrome plating over ABS resin (UL94V-2)
Housing: Glass fiber reinforced polyamide (UL94V-0)
Base: Glass fiber reinforced polyamide (UL94V-0)
Movable Contactor: Phosphor bronze with silver or gold plating
Movable Contacts: Silver alloy or copper with gold plating
Stationary Contacts: Silver alloy or copper with gold plating
Switch Terminals: Phosphor bronze with tin plating
Lamp Terminals: Phosphor bronze with tin plating

Environmental Data

Operating Temperature Range: -25°C through +50°C (-13°F through +122°F) for Illuminated
 -25°C through +70°C (-13°F through +158°F) for Nonilluminated
Humidity: 90 ~ 95% humidity for 240 hours @ 40°C (104°F)
Vibration: 10 ~ 55Hz with peak-to-peak amplitude of 1.5mm traversing the frequency range & returning in 1 minute; 3 right angled directions for 2 hours
Shock: 50G (490m/s²) acceleration (tested in 6 right angled directions, with 5 shocks in each direction)
Sealing: IP65 of IEC60529 standard

Installation

Mounting Torque: 0.785Nm (6.95 lb•in) maximum
Soldering Time & Temperature: Manual Soldering: See Profile A in Supplement section.

Standards & Certifications

Flammability Standards: UL94V-0 housing, base & black bezel
UL: **File No. E44145 - Recognized only when ordered with marking on switch.**
 Add "/CUL" before first dash in part number to order cULus marking on switch.
 All solder lug models recognized at 3A @ 125/250V AC or 0.4VA @ 28V AC/DC maximum.

Distinctive Characteristics

24mm square and 25mm diameter pushbuttons with the shortest above-panel dimension (1.8mm) in the industry for splashproof design.

Meets IP65 of IEC60529 standards (similar to NEMA 4 and 13), providing dust tight and splashproof panel seal protection.

Tamper resistant 18mm square and 19mm diameter actuators.

Short body of .965" (24.5mm) conserves behind-panel space.

Distinctive long stroke and light touch actuation for clear indication of circuit status.

Choice of cap colors includes clear, brushed chrome, red, green, or amber, for enhanced panel appearance. Metallic silver cap option has bright ring illumination (round only).

Brilliant illumination with multiple LED colors.

Bezel color options in black or brushed chrome.

Brushed chrome option is lighter weight than actual metal switches due to metal plating on resin.

Available in momentary and alternate action with latchdown.

Crisp actuation and clear circuit status provided by snap-action contact mechanism. Arc barrier protects against crossover.

Combination solder lug and .110" quick connect terminals. Terminals are epoxy sealed to lock out flux, dust, solvents, and other contaminants, as well as to secure terminals and improve contact stability.

Custom legends on actuator available.

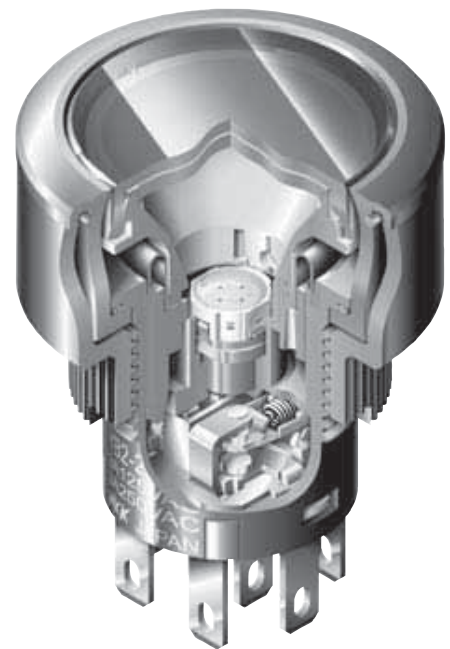

Actual Size (Round)

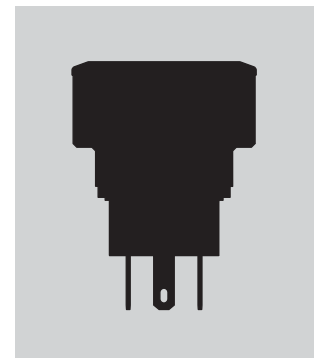

- Toggle
- Rockers
- Pushbuttons
- D** Illuminated PB
- Programmable
- Keylocks
- Rotaries
- Slides
- Tactiles
- Tilt
- Touch
- Indicators
- Accessories
- Supplement

Series YB2

Panel Seal Pushbuttons

TYPICAL SWITCH

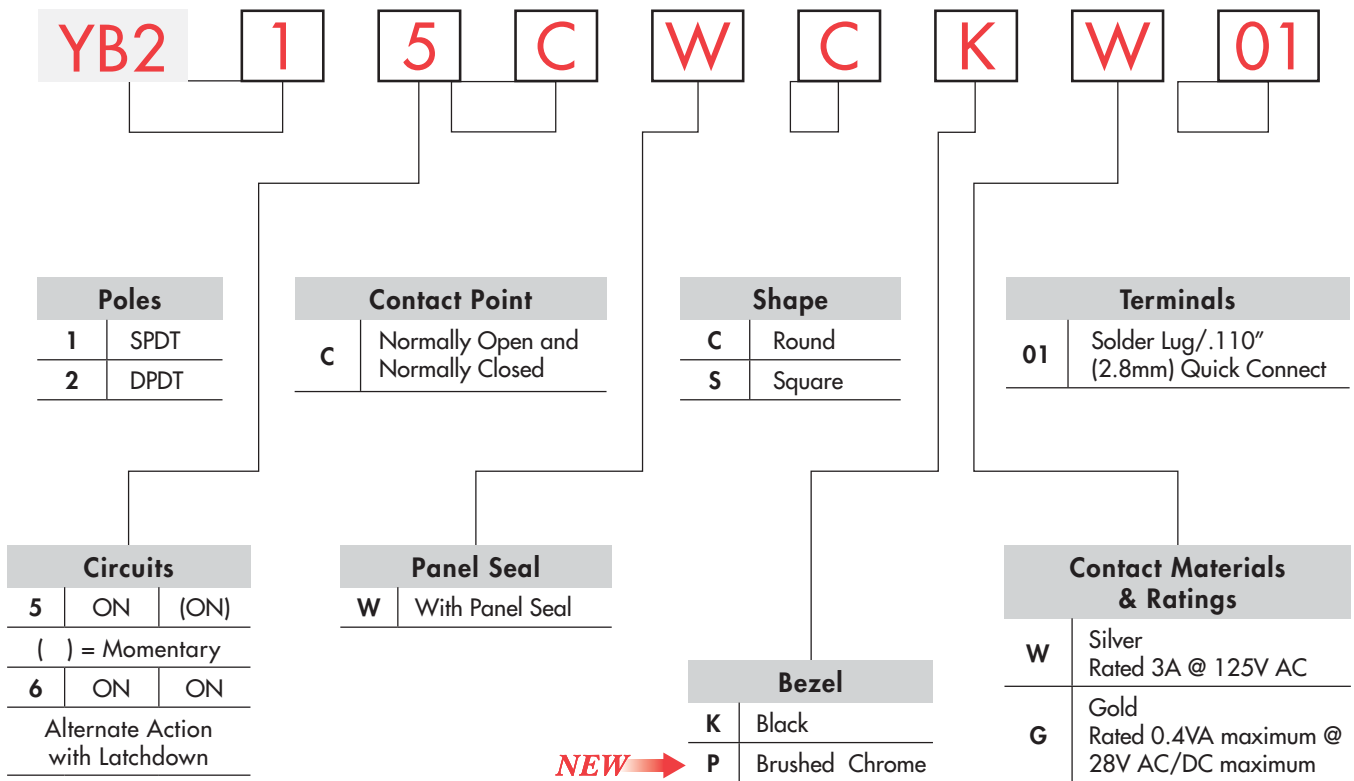

IMPORTANT:



Switches are supplied without cULus marking unless specified.
cULus recognized only when ordered with marking on the switch.
 Specific models, ratings, and ordering instructions are noted on General Specifications page.

DESCRIPTION FOR TYPICAL ORDERING EXAMPLE

YB215CWCKW01-6B-JB



ORDERING EXAMPLE

6 B

LEDS

| Bright LED | | | |
|------------|-------|----------|-----------------------------|
| LED Colors | | Resistor | |
| 5C | Red | No Code | No Resistor (not for Green) |
| 5D | Amber | 05 | 5-volt |
| 5F | Green | 12 | 12-volt |
| | | 24 | 24-volt |

| Super Bright LED | |
|------------------|-------|
| 6B | White |
| 6F | Green |
| 6G | Blue |

| Nonilluminated | |
|----------------|---------|
| N | No Lamp |

JB

Cap Types & Colors

| Lens/Diffuser Colors | |
|----------------------|---|
| JB | Clear/White |
| JS | Metallic Silver Cap/Clear Ring (Round only) |
| CB | Red/White |
| EB | Yellow/White |
| FB | Green/White |

LED and cap need to be the same color. Yellow cap pairs with amber LED to achieve amber illumination. Codes JB and JS (Round only) may be combined with all LED colors.

| Lens/Diffuser Cap Colors | |
|--------------------------|---|
| JB | Clear/White |
| JS | Metallic Silver Cap/Clear Ring (Round only) |

| Cap Color | |
|-----------|----------------|
| JB | Clear/White |
| CB | Red/White |
| EB | Yellow/White |
| FB | Green/White |
| P | Brushed Chrome |

NEW →

DESCRIPTION FOR TYPICAL ORDERING EXAMPLE

YB216CWSPW01-N-P



Series YB2

Panel Seal Pushbuttons

Toggles

Rockers

Pushbuttons

Illuminated PB
D

Programmable

Keylocks

Rotaries

Slides

Tactiles

Tilt

Touch

Indicators

Accessories

Supplement

POLES & CIRCUITS

| Pole | Model | Plunger Position () = Momentary | | Connected Terminals | | Throw & Switch/Lamp Schematics |
|------|----------------|-------------------------------------|------------|---------------------|---------|--|
| | | Normal | Down | Normal | Down | |
| SP | YB215 YB216 | ON ON | (ON) ON | 1-3 | 1-2 | Notes: Switch is marked with NC, NO, COM, L+, L-. Lamp circuit is isolated and requires an external power source. |
| DP | YB225 YB226 | ON ON | (ON) ON | 1-3 4-6 | 1-2 4-5 | |

CONTACT POINT



Normally Open and Normally Closed

Contact points are both Normally Open and Normally Closed.

PANEL SEAL



Panel Seal (Round and Square)

Two o-rings provide panel seal protection meeting IP65 of IEC60529 standards.

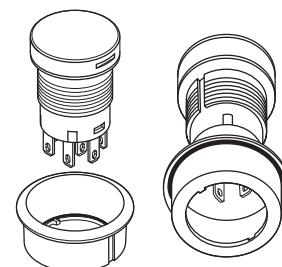

SHAPE



Round



Square

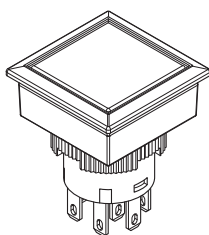
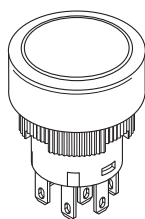

BEZEL



Black



Brushed Chrome

For Round or Square

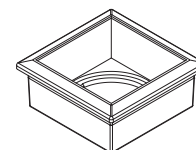
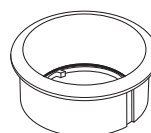

CONTACT MATERIALS & RATINGS



Silver Contacts

Power Level: 3A @ 125/250V AC

Switch base is black



Gold Contacts

Logic Level: 0.4VA max. @ 28V AC/DC max.

Switch base is ivory

TERMINALS



**Solder Lug/
.110" (2.8mm) Quick Connect**

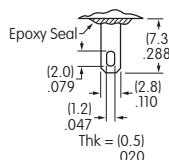

BRIGHT & SUPER BRIGHT LEDs

The electrical specifications shown are determined at a basic temperature of 25°C. LED circuit is isolated and requires an external power source. If the source voltage exceeds the rated voltage, a ballast resistor is required. Base of AT634 and AT636 is Black for 5V, Light Blue for 12V and Gray for 24V.

Electrical Specifications for Bright LED without Resistor

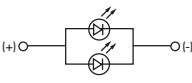
| | | |
|---|--|-------------------------|
| Bright AT628  T-1 Bi-pin  | Colors Available: 5C Red 5D Amber No Code No Resistor | Unit |
| | LED Colors | Red Amber |
| | Forward Peak Current | I_{FM} 40 40 mA |
| | Typical Forward Current | I_F 26 26 mA |
| | Forward Voltage | V_F 1.9 2.0 V |
| | Reverse Peak Voltage | V_{RM} 4 4 V |
| | Current Reduction Rate Above 25°C | ΔI_F 0.50 mA/°C |
| Ambient Temperature Range | -25 ~ +50 °C | |

Electrical Specifications for Bright Red & Amber LED with Resistor

| | | |
|---|---|--------------------------|
| Bright AT634  T-1 1/4 Bi-pin | Colors Available: 5C Red 5D Amber 05 12 24 | Unit |
| | Forward Peak Current | I_{FM} — — — mA |
| | Typical Forward Current | I_F 25 20 10 mA |
| | Forward Voltage | V_F 5 12 24 V |
| | Reverse Peak Voltage | V_{RM} 4 8 16 V |
| | Current Reduction Rate Above 25°C | ΔI_F — — — mA/°C |
| | Ambient Temperature Range | -25 ~ +50 °C |

AT634
5-volt,
2-element
with Resistor





AT634
12-volt,
4-element
with Resistor



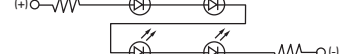

AT634
24-volt,
4-element
with Resistor



Electrical Specifications for Bright Green LED with Resistor

| | | |
|---|---|--------------------------|
| Bright AT636  T-1 1/4 Bi-pin 5V 12V & 24V | Colors Available:  ATTENTION ELECTROSTATIC SENSITIVE DEVICES 5F Green 05 12 24 | Unit |
| | Forward Peak Current | I_{FM} — — — mA |
| | Typical Forward Current | I_F 11 9.5 8.7 mA |
| | Forward Voltage | V_F 5 12 24 V |
| | Reverse Peak Voltage | V_{RM} 5 5 5 V |
| | Current Reduction Rate Above 25°C | ΔI_F — — — mA/°C |
| | Ambient Temperature Range | -25 ~ +50 °C |

Electrical Specifications for Super Bright LED

| | | |
|--|---|-----------------------------------|
| Super Bright AT625G Blue AT631B White AT632F Green  T-1 Bi-pin |  ATTENTION ELECTROSTATIC SENSITIVE DEVICES 6B 6F 6G | Unit |
| | Colors: | White Green Blue |
| | Forward Peak Current | I_{FM} 30 30 30 mA |
| | Typical Forward Current | I_F 20 20 20 mA |
| | Forward Voltage | V_F 3.6 3.5 3.6 V |
| | Reverse Peak Voltage | V_{RM} 5 5 5 V |
| | Current Reduction Rate Above 25°C | ΔI_F 0.50 0.50 0.50 mA/°C |
| Ambient Temperature Range | -25 ~ +50 °C | |

Toggles
 Rockers
 Pushbuttons
 Illuminated PB
 Programmable
 Keylocks
 Rotaries
 Slides
 Tactiles
 Tilt
 Touch
 Indicators
 Accessories
 Supplement

BALLAST RESISTOR CALCULATION FOR LEDs

If the source voltage is greater than the rated voltage of a lamp or LED, a ballast resistor must be connected in series with the lamp. This circuit diagram and formula will assist in calculating the value of the required ballast resistor.

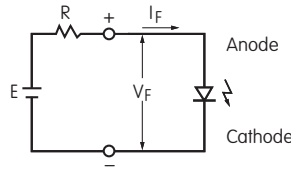

$$R = \frac{E - V_F}{I_F}$$

Where: R = Resistor Value (Ohms)
E = Source Voltage (V)
V_F = Forward Voltage (V)
I_F = Forward Current (A)

CAPS & CAP COLORS

AT3017 Cap for Bright LED

Lens/Diffuser Colors Available:

- JB** Clear/White
- CB** Red/White
- EB** *Yellow/White
- FB** Green/White

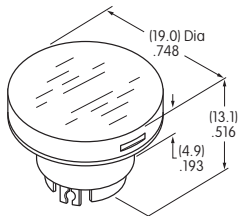

*Yellow cap pairs with amber LED to achieve amber illumination.

AT3018 Cap for Super Bright LED

Lens/Diffuser Colors Available:

- JB** Clear/White

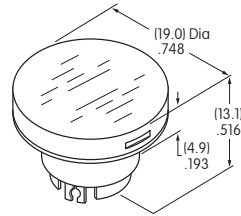

Material for Lens & Diffuser: Polycarbonate

AT3019 Cap for Nonilluminated

Cap Color Available:

- P** Brushed Chrome

Note: AT3017 Cap can also be used without illumination.

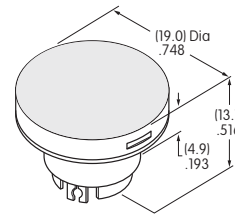

Material for Lens: ABS Resin and Brushed Chrome Plating

AT3020 Cap with Illumination Ring for Bright or Super Bright LED

Cap Color Available:

- JS** Metallic Silver with Clear Ring

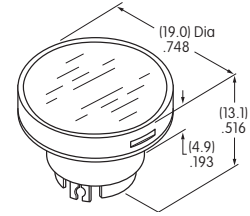

Materials
Lens: Polycarbonate
Insert: Polyester

AT3025 Cap for Illuminated

Lens/Diffuser Colors Available:

- JB** Clear/White For Bright & Superbright LEDs
- CB** Red/White For Bright LED only
- EB** *Yellow/White For Bright LED only
- FB** Green/White For Bright LED only

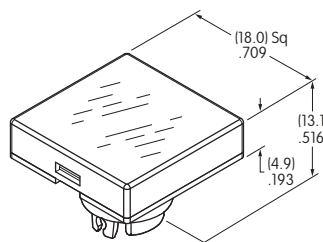

Material for Lens & Diffuser: Polycarbonate

*Yellow cap pairs with amber LED to achieve amber illumination.

AT3027 Cap for Nonilluminated

Cap Color Available:

- P** Brushed Chrome

Note: AT3025 Cap can also be used without illumination.

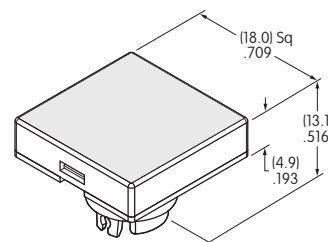

Material for Lens: ABS Resin and Brushed Chrome Plating

TYPICAL SWITCH DIMENSIONS

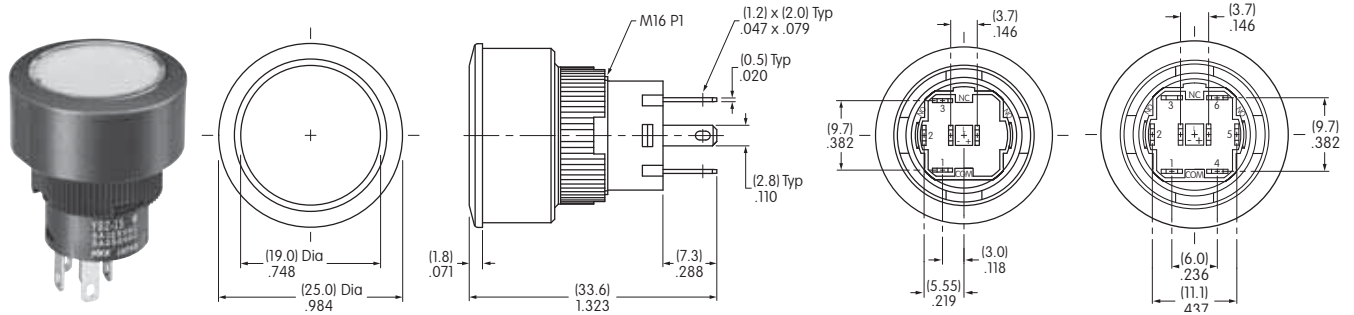

YB215CWCKW01-6B-JB

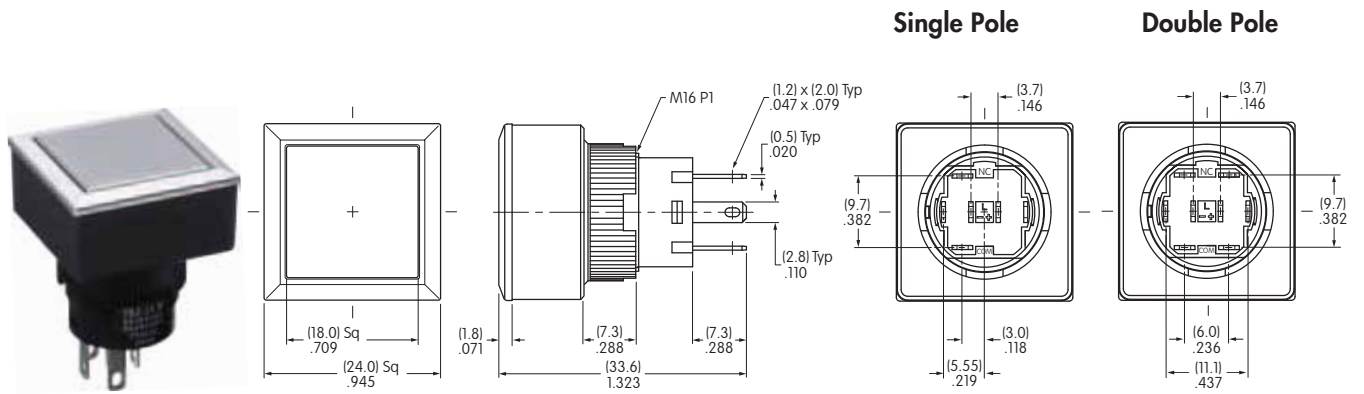

YB216CWSPW01-N-P

PANEL THICKNESS & CUTOUT

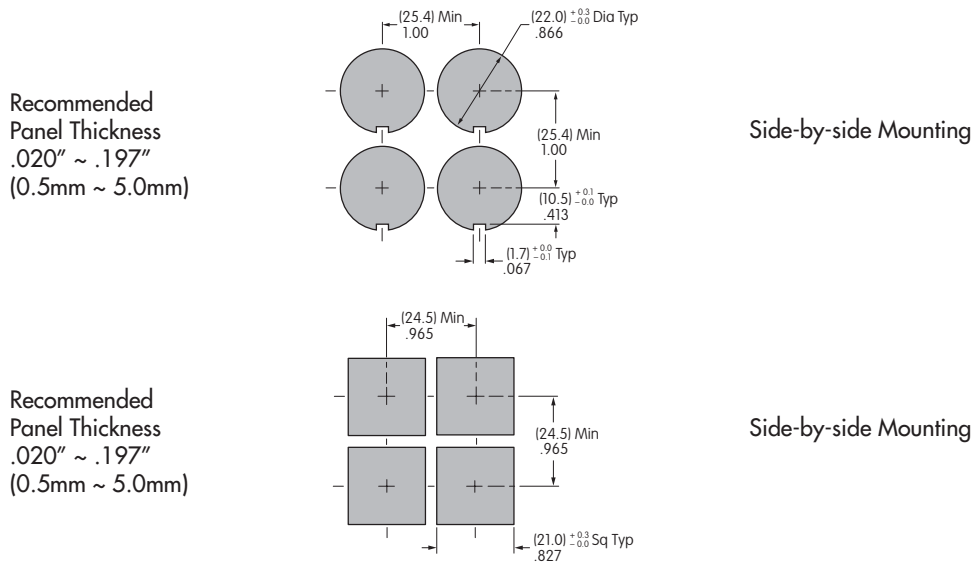

ASSEMBLY INSTRUCTIONS FOR ROUND

1. Remove knurled mounting nut.

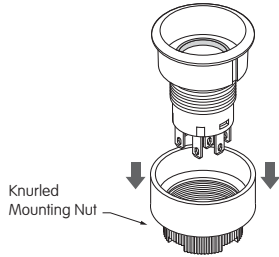

5. Install the red o-ring which was removed in step 2 at the inside bottom of the bezel.

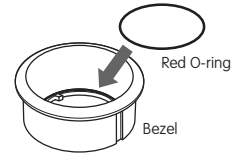

2. Remove bezel and red o-ring from housing. There are two o-rings in this assembly: one is red, one is orange.

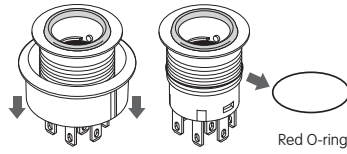

6. Align tab inside of the bezel with keyway on housing and bring bezel back into its original position.

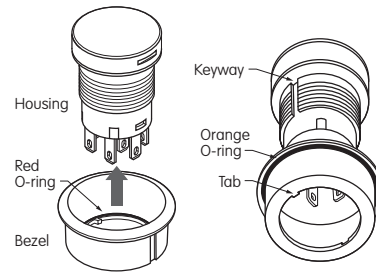

3. Install LED.

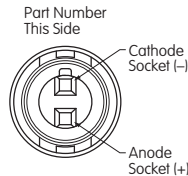

7. Before installing into panel, make sure that the orange o-ring is present at the back of the bezel. Align keyway on bezel with tab in panel and push switch all the way into the panel.

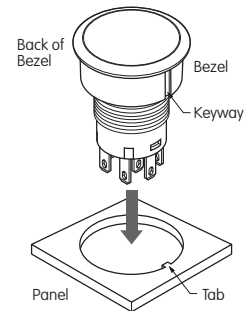

LEDs
AT634 & AT636

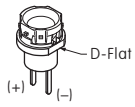

Align D-flat on LED with Part Number on switch for appropriate polarity and insert LED into base.



LED AT628

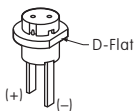

Align D-flat on LED with Part Number on switch for appropriate polarity and insert LED into base.



LEDs AT625G,
AT631B,
AT632F

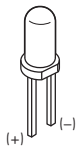

The larger metal part within the LED represents the cathode (-). Align LED for appropriate polarity and insert LED into base.

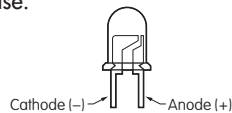

4. Align tabs (B) on both sides of actuator with the projections (A) inside of the housing and push actuator firmly down to snap in.

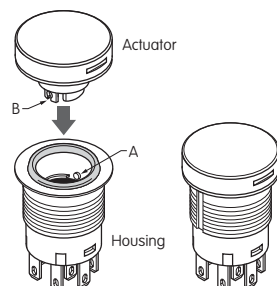

8. Attach mounting nut behind panel and tighten. Make sure that bezel and actuator fit properly and that there is no space between bezel and panel. Do not overtighten.

Mounting torque: 0.785Nm (6.95 lb•in) maximum.
Optional socket wrench AT106 available.

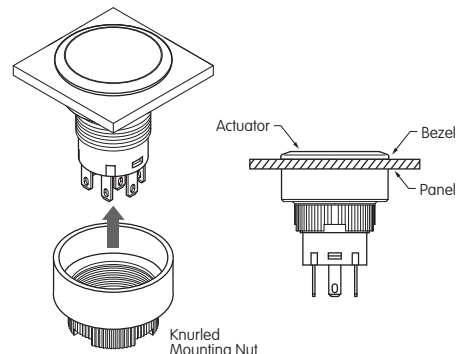

AT106 Socket Wrench



ASSEMBLY INSTRUCTIONS FOR SQUARE

1. Remove knurled mounting nut.

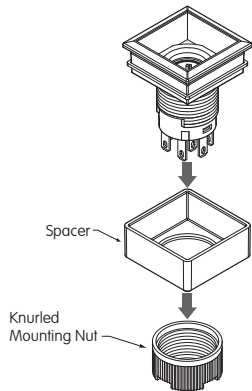

2. Remove bezel and blue o-ring from housing.

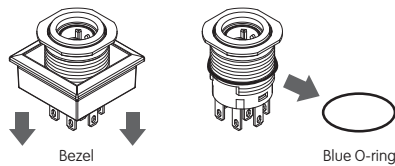

3. Install LED.

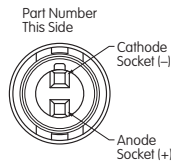

LEDs AT634 & AT636

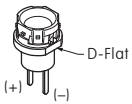

Align D-flat on LED with Part Number on switch for appropriate polarity and insert LED into base.



LED AT628

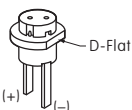

Align D-flat on LED with Part Number on switch for appropriate polarity and insert LED into base.



LEDs AT625G, AT631B, AT632F

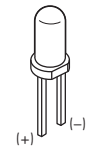

The larger metal part within the LED represents the cathode (-). Align LED for appropriate polarity and insert LED into base.

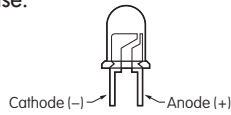

4. Align tabs (B) on both sides of actuator with the projections (A) inside of the housing and push actuator firmly down to snap in.

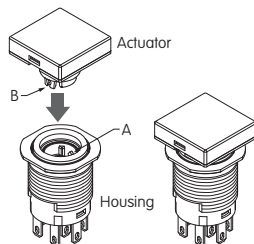

5. Install the blue o-ring which was removed in step 2 at the inside bottom of the bezel.

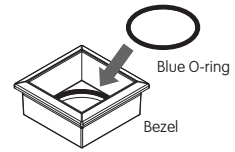

6. Align tab inside of the bezel with keyway on housing and bring bezel back into its original position.

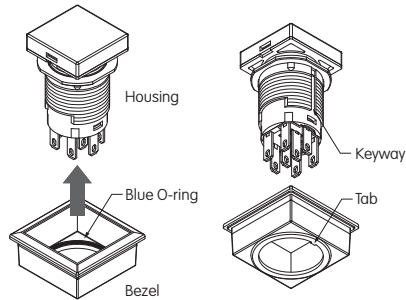

7. Before installing into panel, make sure that the square gasket is present at the back of the bezel. Align keyway on bezel with tab in panel and push switch all the way into the panel.

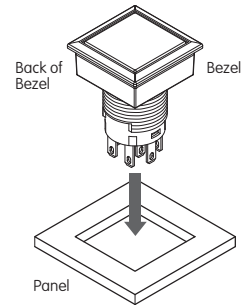

8. Attach mounting nut behind panel and tighten. Make sure that bezel and actuator fit properly and that there is no space between bezel and panel. Do not overtighten.

Mounting torque: 0.785Nm (6.95 lb•in) maximum. Optional socket wrench AT106 available.

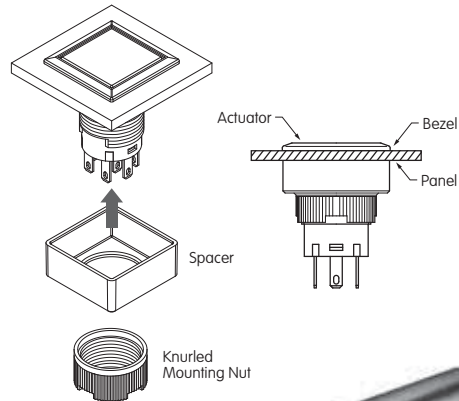

AT106 Socket Wrench



Toggles

Rockers

Pushbuttons

Illuminated PB

Programmable

Keylocks

Rotaries

Slides

Tactiles

Tilt

Touch

Indicators

Accessories

Supplement

LEGENDS

NKK Switches can provide custom legends for caps. Contact factory for more information.

Suggested Printable Area for YB2 Caps

Recommended Methods: Laser Etch on clear cap, Screen Print or Pad Print on cap.
Epoxy based ink is recommended.

For Caps
AT3017, AT3018, and AT3019

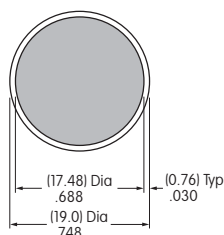

For Cap
AT3020 (with clear ring for illumination)

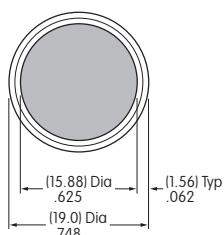

For Caps
AT3025 and AT3027

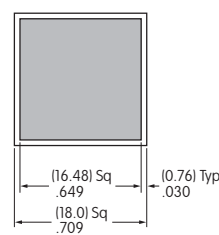

Shaded areas are printable areas.

Suggested Printable Area for Film Inserts

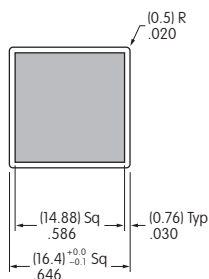
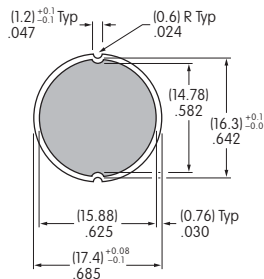

Recommended Method:
Screen Print; Epoxy based ink is recommended

Film Material and Thickness:
Clear Polyester, 4 mil max.

Shaded areas are printable areas.

HANDLING & PRECAUTIONS



LEDs are electrostatic sensitive devices. When installing and handling LEDs, use an electrostatic protected work station to prevent LED damage.