

MICROWAVE TYPE LEVEL SWITCH

Model **MWS2-24TN/24RN**

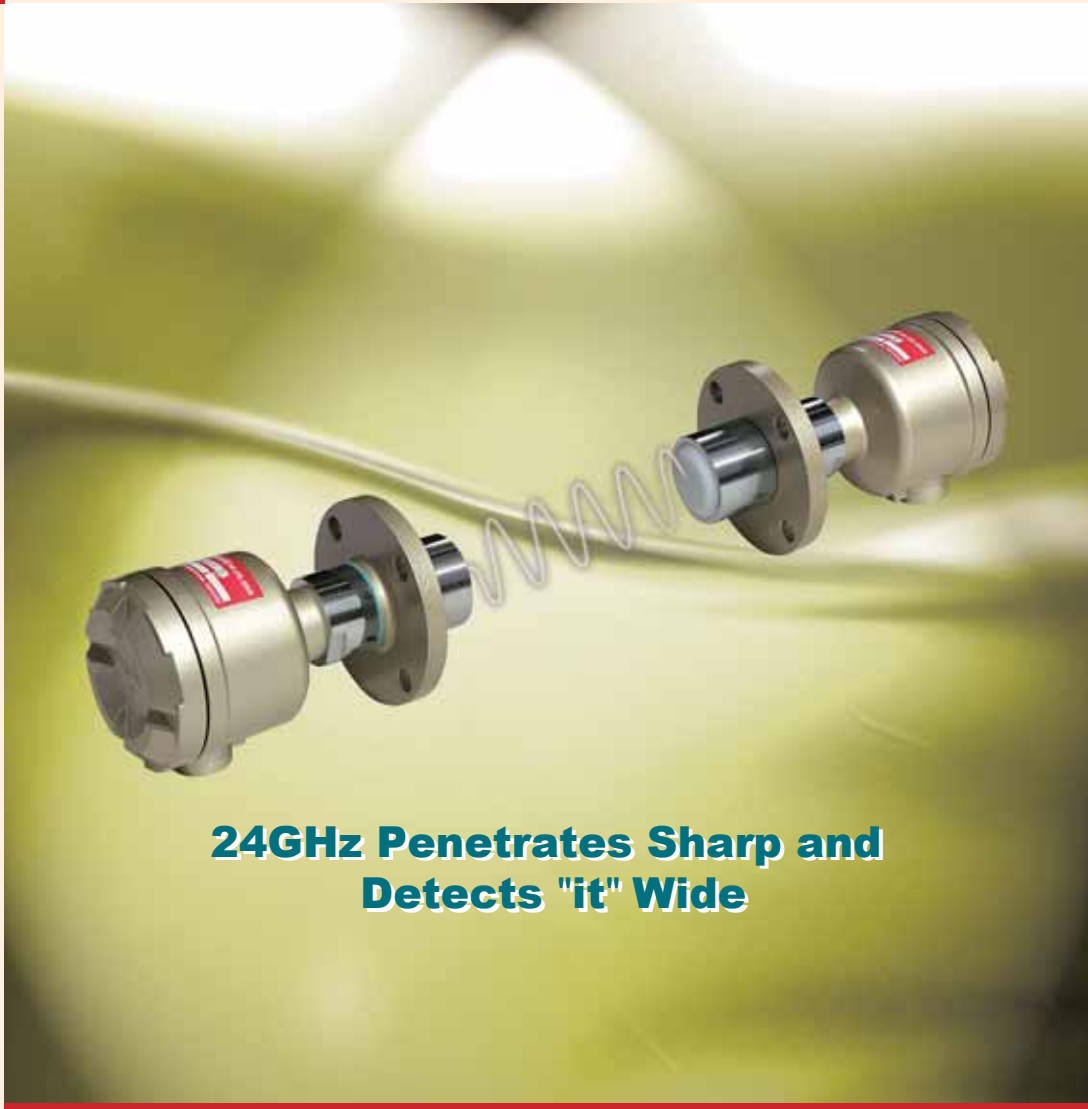

**24GHz Penetrates Sharp and
Detects "it" Wide**

MWS2-24TN/24RN MICROWAVE TYPE LEVEL SWITCH

RELIABLE DETECTION FOR WASTES, COAL, BALLAST, GRANULES AND OTHERS

24GHz Microwave— Compact, Light and Quality Level Switch

- It may hardly be affected by dirt, fouling, or scale adhesion on the sensing surface.
- A new type of transmitter and receiver of 24GHz being adopted, it is compact and light.
- Wiring and necessary adjustment are easier with a new design on P.C.B.
- It can accurately detect the paper garbage whose detection was impossible by any other detecting methods.

■ OPERATING PRINCIPLE

MWS2 Type Microwave Switch is a level switch consisting of a transmitter and a receiver, both of which are installed face to face each other. The transmitter (MWS2-24TN) transmits microwaves in 24GHz toward the receiver (MWS2-24RN), which, upon receipt of them, provides an output of the contact signals that the tank is empty. When there is an obstruction between the transmitter and the receiver, however, microwaves are reflected and absorbed, thus making the receiver unable to receive them and outputting the contact signals that the tank is full.

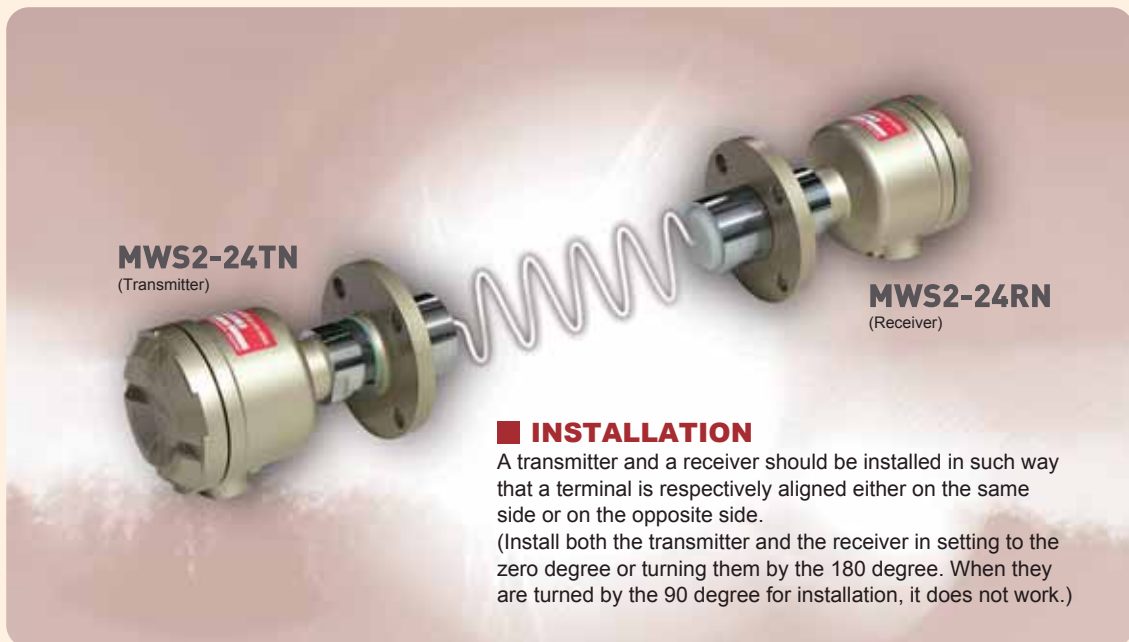

■ INSTALLATION

A transmitter and a receiver should be installed in such way that a terminal is respectively aligned either on the same side or on the opposite side.
 (Install both the transmitter and the receiver in setting to the zero degree or turning them by the 180 degree. When they are turned by the 90 degree for installation, it does not work.)

SPECIFICATIONS

Type Designation: Transmitter = MWS2-24TN
 Receiver = MWS2-24RN
Power Supply: AC105V/210V ±10% 50/60Hz
Frequency: 24GHz
Operating Distance: Switching System by Range SW

Switch Position	Setting Detroct
1	15m
2	25m
3	35m

•It is set to [1] in shipment

Output: 1×SPDT, 250V AC, 5A
Delay Function: ON Delay 0.1 to 10 seconds
Power Consumption: Transmitter 2VA, Receiver 5VA
Ambient Temperature: -20°C~+60°C
Housing: IP-55 equivalent
Color: Silver
Weight: Transmitter 1.5kg,
 Receiver 1.6kg
Flange: 5K 50A JIS (AC)

PRODUCT LINEUP

MWS2-24TN/RN Standard Flange Type

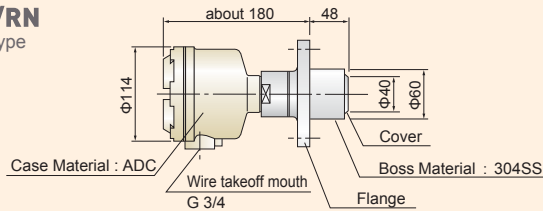

Temperature limit	max.60°C
Usage environment	Outdoor
Flange Size	JIS 5K50A/AC
Cover Material	PA
Setting distance	max.35m

JIS 5K65A, AC/304SS Possible production

MWS2-24TN/RN-G Screwed-Joint Type

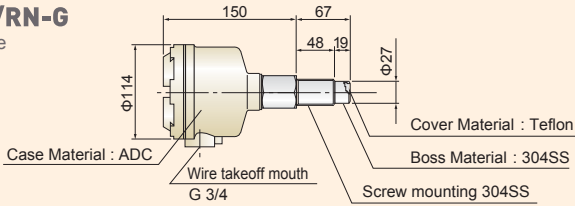

Temperature limit	max.60°C
Usage environment	Outdoor
Flange Size	G1(Screwed)/304SS
Cover Material	Teflon
Setting distance	max.1m

MWS2-24TN/RN-H1 Heat-resistant Nozzle Type

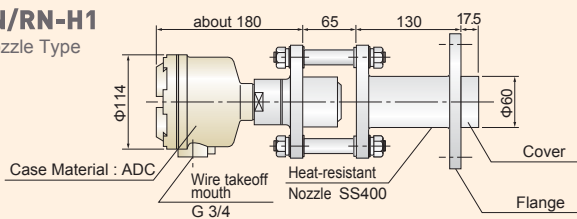

Temperature limit	max.180°C
Usage environment	Indoor
Flange Size	JIS 5K65A/SS400
Cover Material	Teflon
Setting distance	max.35m

MWS2-24TN/RN-H2,H3 Heat-resistant Type

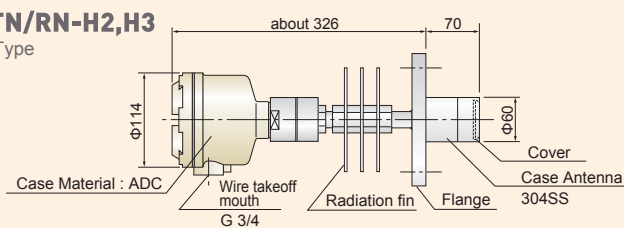

MODEL	Temperature limit	Gasket Material
MWS2-24TN/RN-H2	max.250°C	Nonasbestos
MWS2-24TN/RN-H3	max.400°C	Graphite

Usage environment	Outdoor
Flange Size	JIS 5K65A/SUS304
Cover Material	Ceramic
Setting distance	max.3m

MWS2-24TN/RN-H2,H3 Heat-resistant Waveguide Extension Type

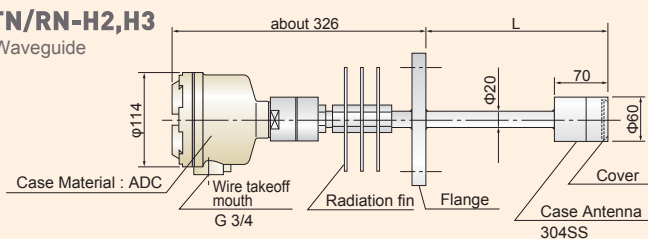

MODEL	Temperature limit	Gasket Material
MWS2-24TN/RN-H2	max.250°C	Nonasbestos
MWS2-24TN/RN-H3	max.400°C	Graphite

Usage environment	Outdoor
Flange Size	JIS 5K65A/SUS304
Cover Material	Ceramic
Setting distance	max.3m

INSTALLATION

*Use temperature of 400°C or more are required for meeting
 *Model specifications for resistance to vibration all measures (resin filling) model is available at the end of production - it comes with M DC24V production specification also available (optional)

WIRING

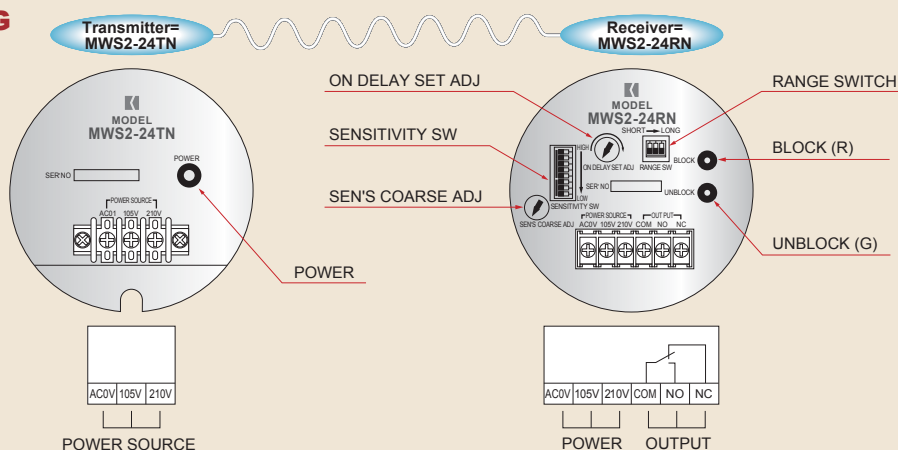

APPLICATIONS

In a sealed metal used in place please

The Level of feed grains coal waste ore discovery

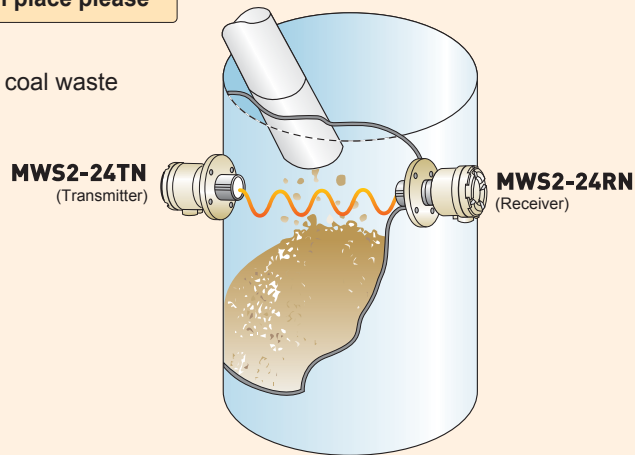

Dust in many places suitable for the environment is bad

Shutter of a vehicle best switchgear

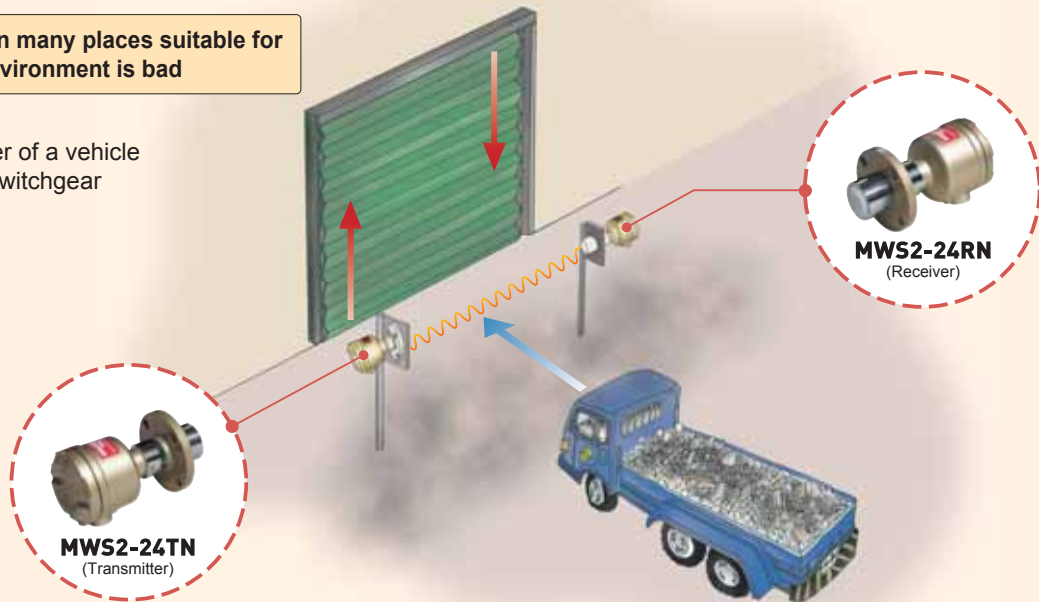

Line of business

- Rotary Paddle Type Level Switch
- Vibration Type Level Switch
- Swing Type Level Switch
- Acoustic Level Switch
- Capacitance Type Level Switch
- Capacitive Proximity Sensor
- Capacitance Type Level Indicator
- Diaphragm Type Level Switch
- Tilt Switch
- Leak Type Level Switch
- Microwave Switch
- Sounding Bob Type Level Indicator
- Flow Switch
- Conductance Type Level Switch
- Float Switch
- Float Type Level Indicator
- Ultrasonic Type Level Indicator
- Equipments For Conveyor Lines
- Dust Monitor System
- Zirconia Oxygen Analyzer
- Laser Type Level Indicator
- RADAR Type Level Indicator
- On-line Sensors for Accurate Liquid Analysis
- Ultrasonic Flow meter

Nuclear Power Generation to Rice Milling
 All-round Manufacturer of Level Controllers for Powder, Granules and Liquid

KANSAI Automation Co., Ltd.



Design, development, and manufacture of level measuring sensors

*Please be sure to read USER'S GUIDE, Installation & Operation Instructions before using the instrument.

*The specifications herein may be subject to change without advance notice.

Agent